



(D) Videounterstützte Montageanleitung

(TR) Video destekli kurulum talimatları

(RU) инструкция по монтажу с помощью видеосигнала

(RO) Instrucțiuni de instalare acceptate video

(GB) Video-assisted assembly instructions

(IT) Istruzioni di montaggio video-assistite

(CZ) Instalační pokyny podporované videem

(PL) Instrukcje montażu wspomagane sygnałem wizyjnym

(FR) Instructions de montage assistées par vidéo

(NL) Video-ondersteunde montage-instructies

(HU) Video-támogatott telepítési utasítások

(SK) Inštačné pokyny podporované videom

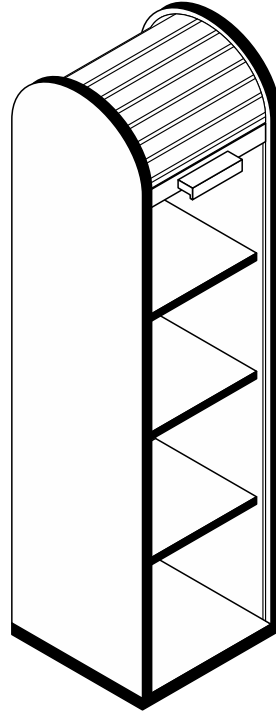
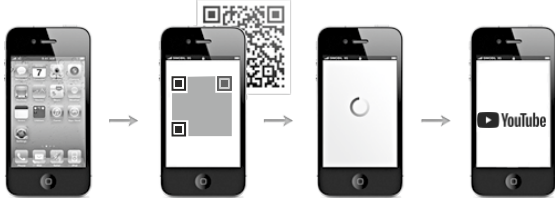

Art.Nr. : **780-RL_46-192**

Jalousieschrank





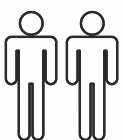
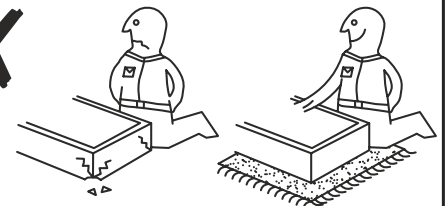
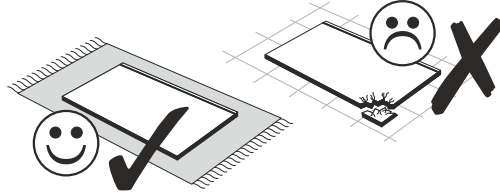
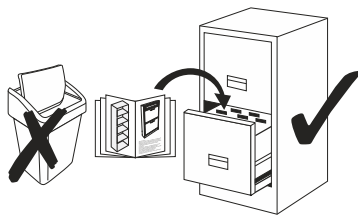
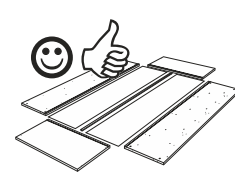
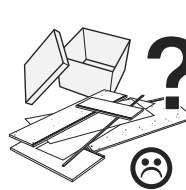
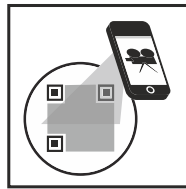
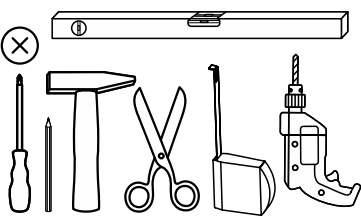

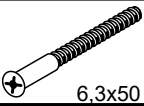

REPC-Nr.:

**Service • Assistenza • Dienstverlening • Serwis
Servis • Szerviz • Сервисная служба**

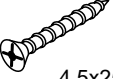



Das Ersatzteil-Anforderungsformular finden Sie auf <https://www.maeusbacher.de/ersatzteile/>

BT1-00157 Colli 2/2

B01-10 4x  6,3x50	B01-30 8x  3x16	B01-37 1x  4,5x25	B01-90 4x  3,5x20	B01-122 3x  4x13	B01-190 2x  M4x20
B02-10 8x 	B02-20 8x 	B02-160 10x 			

BT1-00160 Colli 2/2

B02-170 4x 	B06-401 1x 	B06-490 1x 
--	--	--

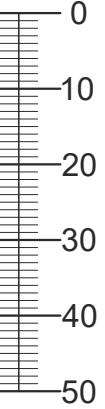
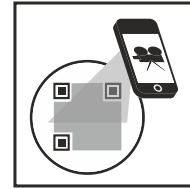

Colli 1/2

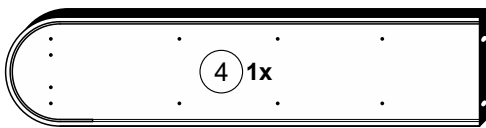

1880 x 432
FTx-000243

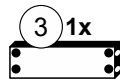

416 x 124
FTx-000251

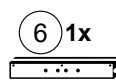

410 x 60
FTx-000253

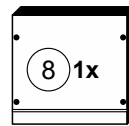

455 x 432
FTx-000249

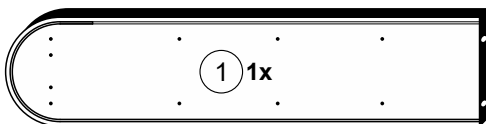

1880 x 432
FTx-000243

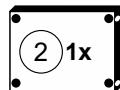

416 x 320
FTx-000252

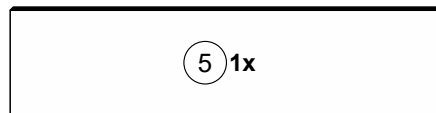

1716 x 416
HTR-00409

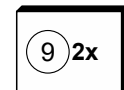

416 x 320
FTx-000250

Colli 2/2

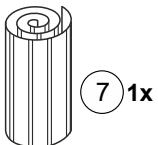

2262 x 430
Z18-13-2262

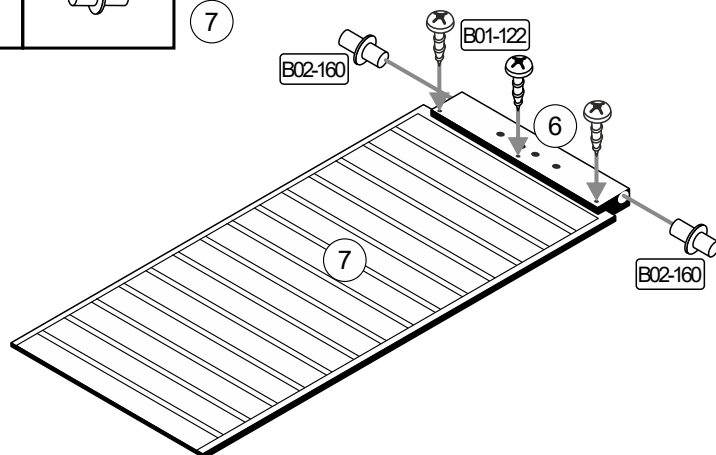
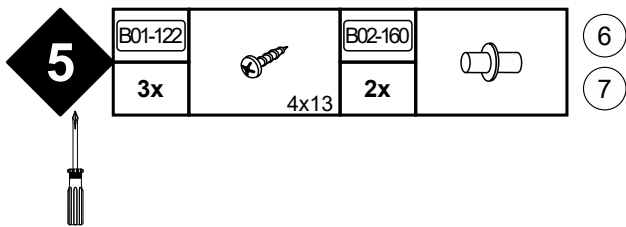
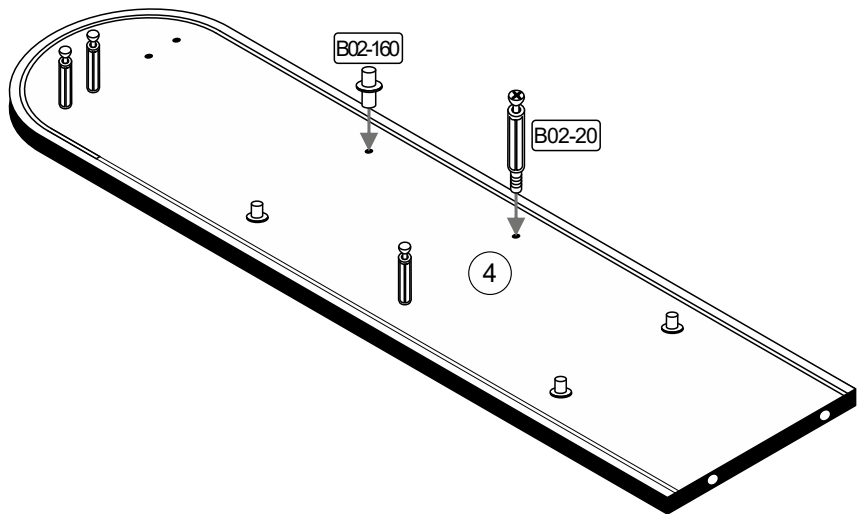
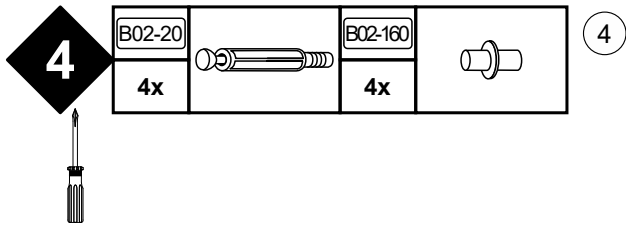
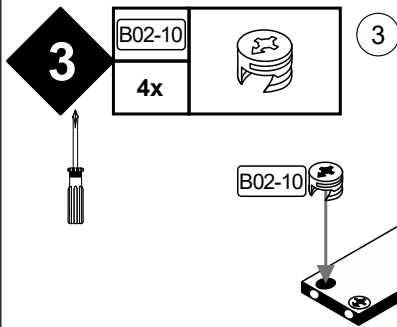
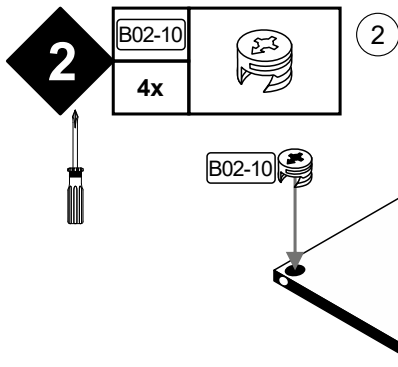
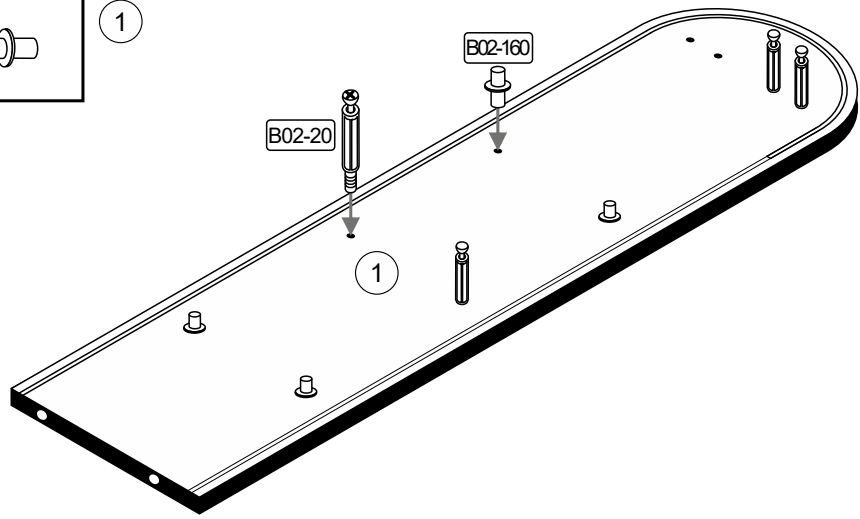
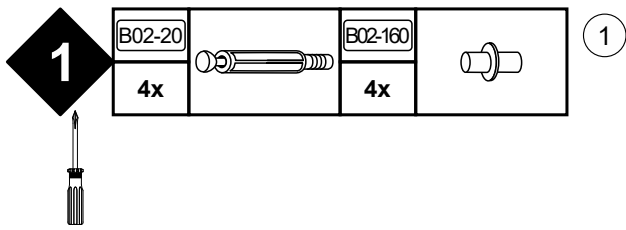

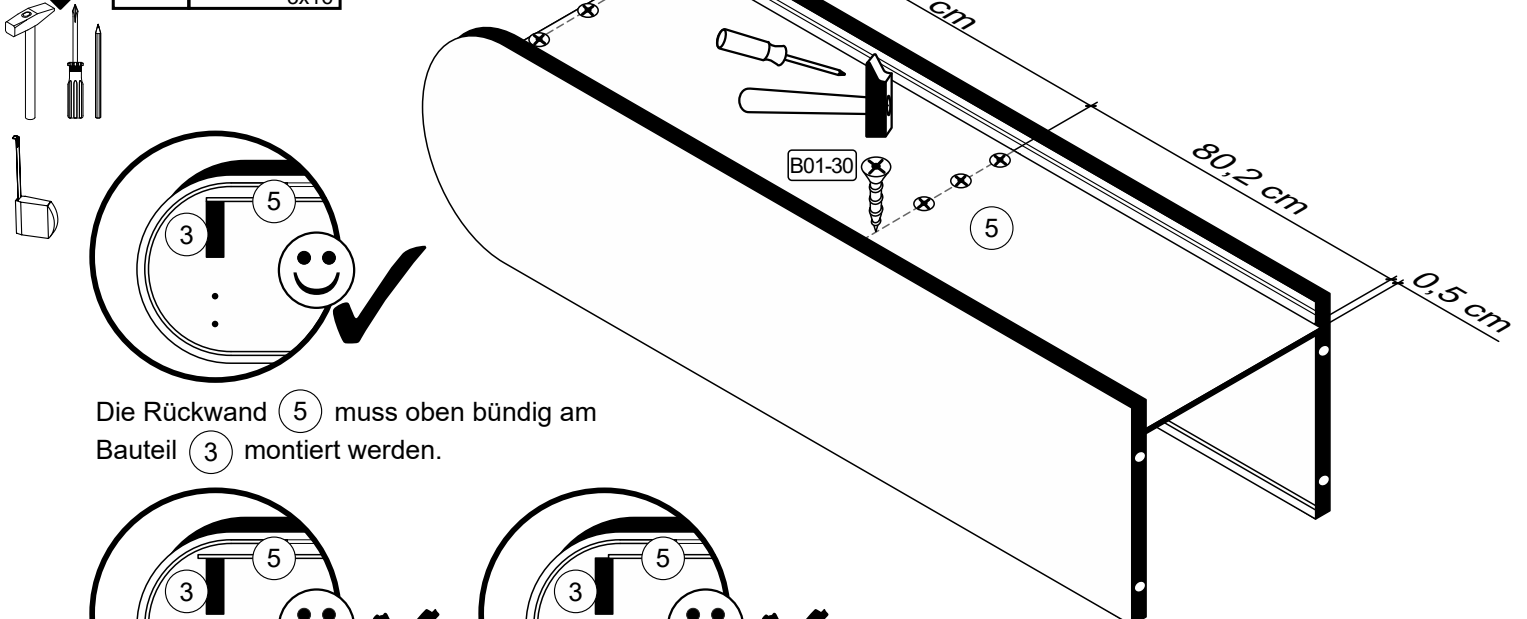
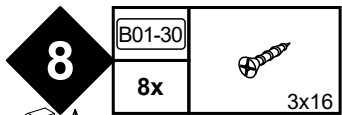
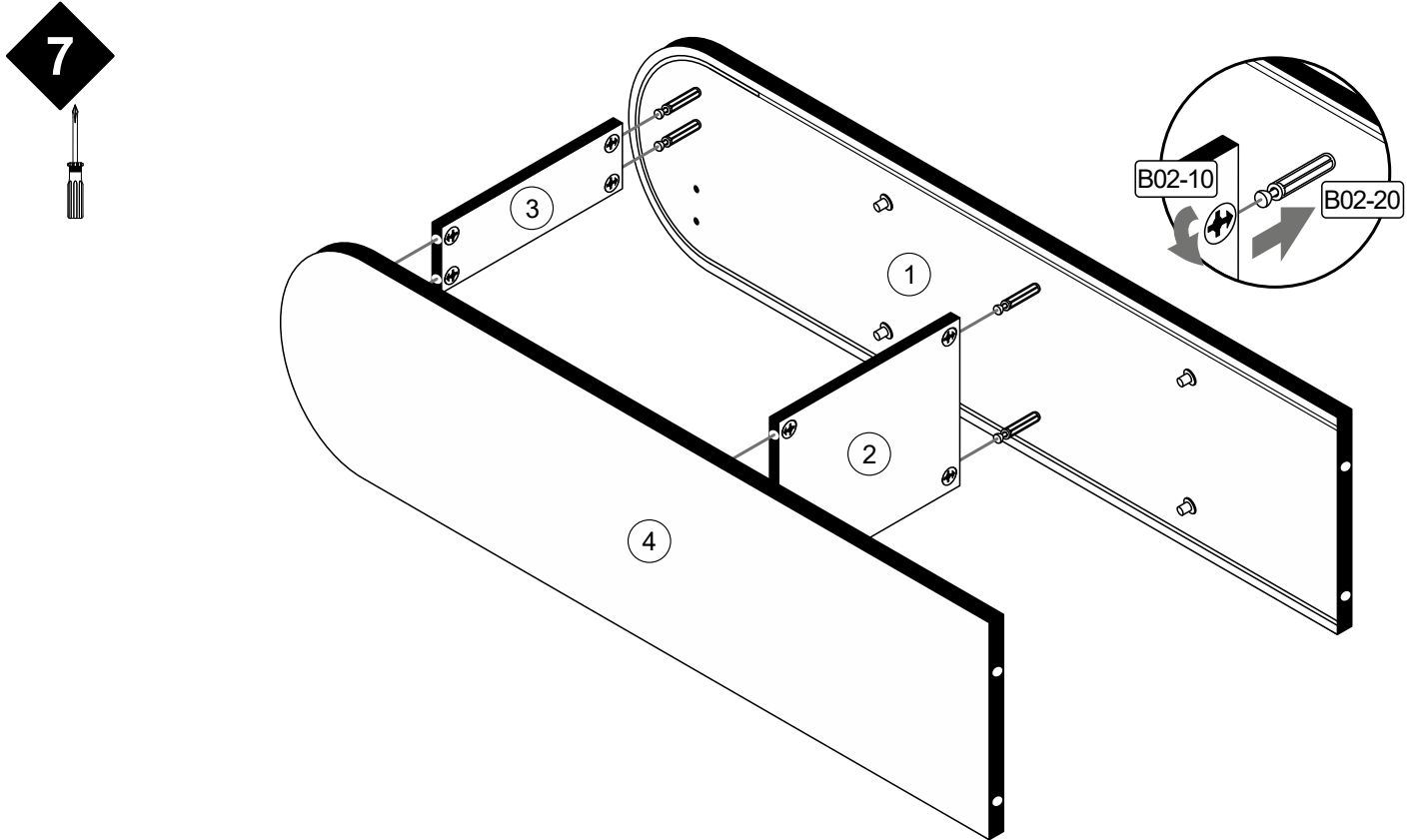
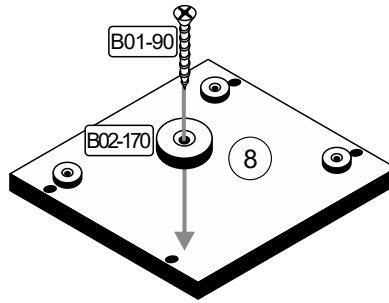
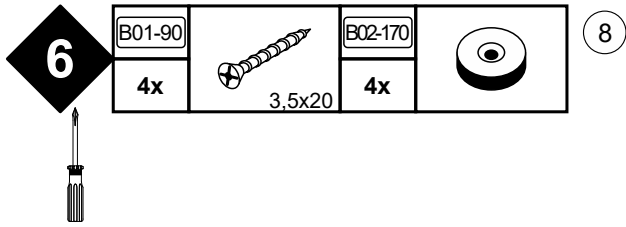

Die Rückwand (5) muss oben bündig am Bauteil (3) montiert werden.

9

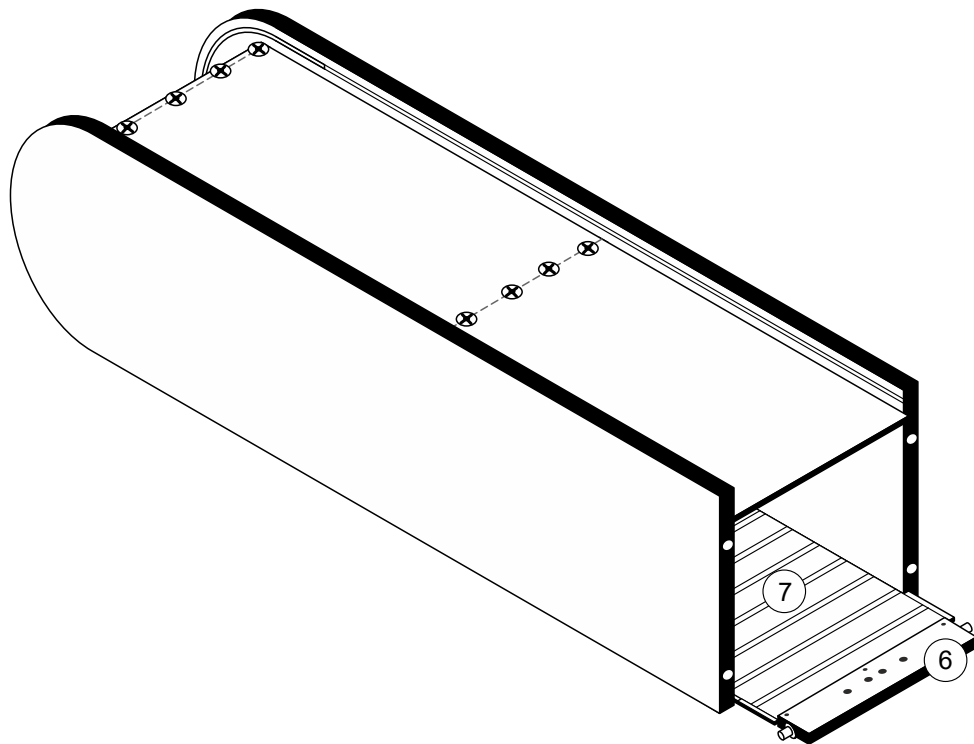

10



B01-10	
4x	6,3x50

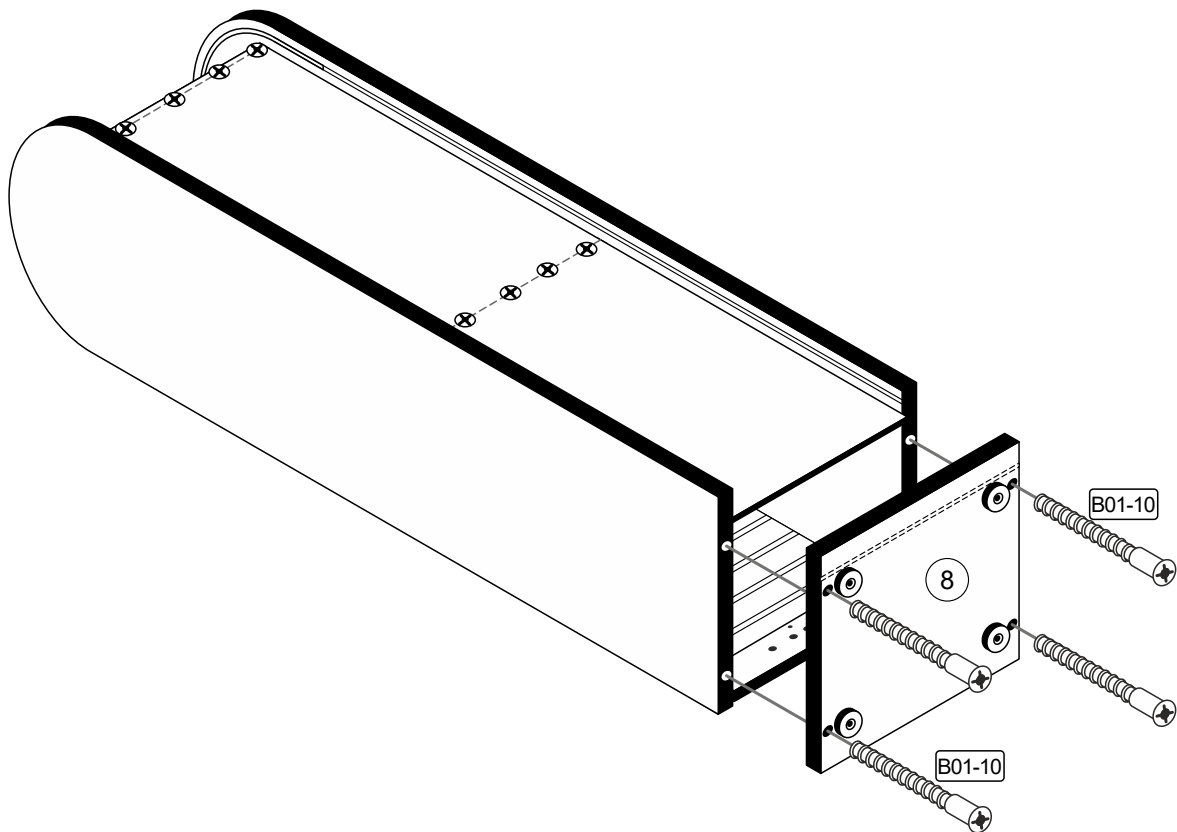

11



B01-37		B01-190		B06-401		B06-490	
1x	4,5x25	2x	M4x20	1x		1x	

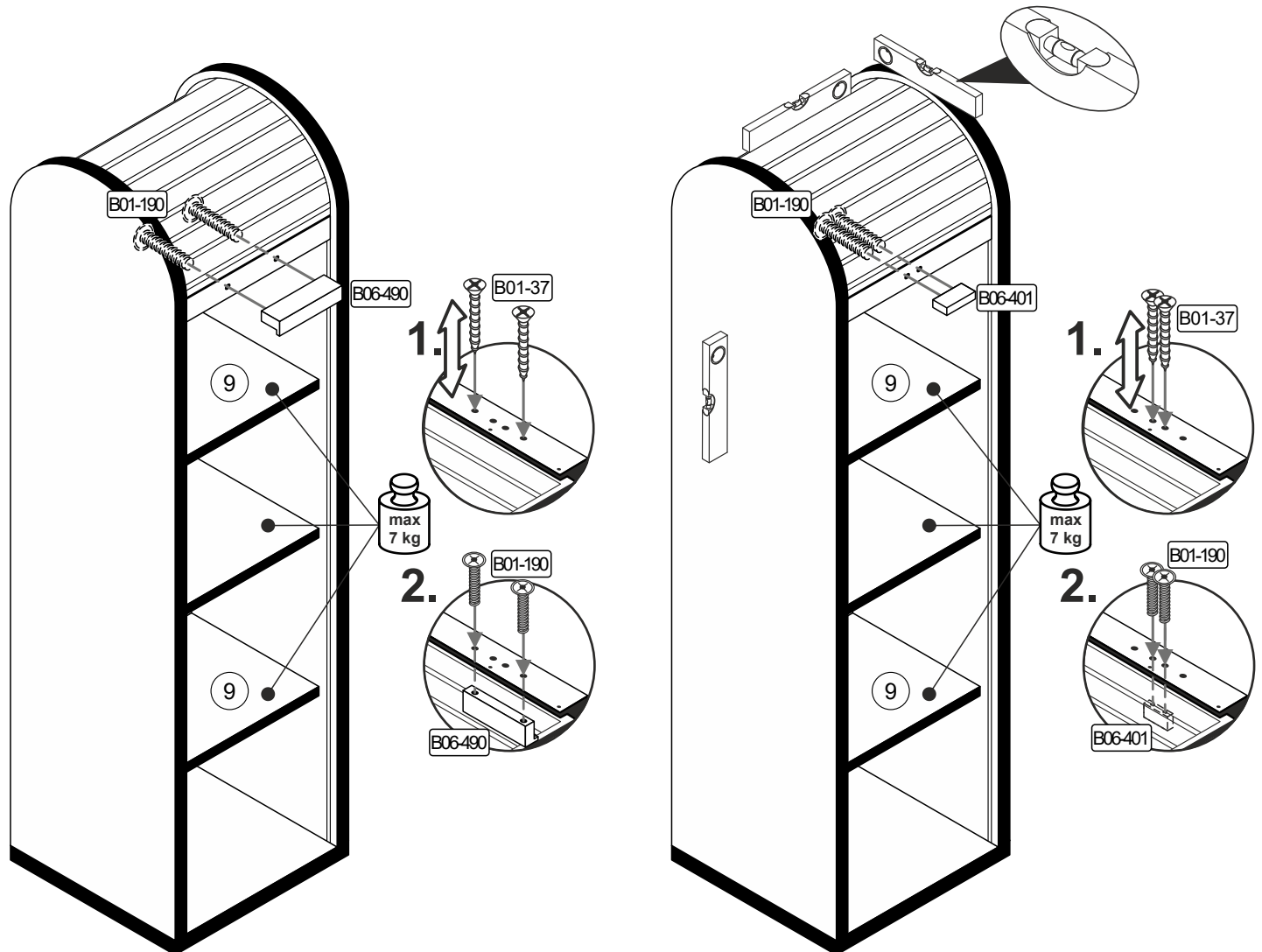
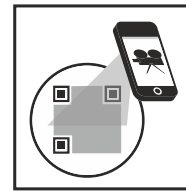

**Sicherheitshinweise • Safety instructions •
 Consignes de sécurité • Güvenlik uyarıları •
 Norme di sicurezza • Veiligheidsinstructies •
 Правила техники безопасности •
 Bezpečnostní pokyny • Biztonságtechnikai
 tudnivalók • Instrucțiuni referitoare la siguranță •
 Wskazówki bezpieczeństwa • Bezpečnostné
 pokyny**

